



INSTALLATION AND VERIFICATION MANUAL

HP 70904A/5A/5B/6A/6B RF SECTIONS

SERIAL NUMBERS

This manual applies directly to HP 70904A/5A/5B/6A/6B RF
Sections with the following serial number prefixes:

HP 70904A: 2429A and below
HP 70905A: 2631A and below
HP 70905B: 2724A and below
HP 70906A: 2723A and below
HP 70906B: 2743A

COPYRIGHT © 1988 HEWLETT-PACKARD COMPANY
1212 VALLEY HOUSE DRIVE, ROHNERT PARK, CALIFORNIA 94928-4999, U.S.A.

Manual Part Number: 5958-6920
Microfiche Part Number: 5958-6674

Printed: June 1988

CERTIFICATION

Hewlett-Packard Company certifies that this product met its published specifications at the time of shipment from the factory. Hewlett-Packard further certifies that its calibration measurements are traceable to the United States National Bureau of Standards, to the extent allowed by the Bureau's calibration facility, and to the calibration facilities of other International Standards Organization members.

WARRANTY

This Hewlett-Packard instrument product is warranted against defects in material and workmanship for a period of one year from date of shipment. During the warranty period, Hewlett-Packard Company will, at its option, either repair or replace products which prove to be defective.

For warranty service or repair, this product must be returned to a service facility designated by HP. Buyer shall prepay shipping charges to HP and HP shall pay shipping charges to return the product to Buyer. However, Buyer shall pay all shipping charges, duties, and taxes for products returned to HP from another country.

HP warrants that its software and firmware designated by HP for use with an instrument will execute its programming instructions when properly installed on that instrument. HP does not warrant that the operation of the instrument, or software, or firmware will be uninterrupted or error-free.

LIMITATION OF WARRANTY

The foregoing warranty shall not apply to defects resulting from improper or inadequate maintenance by Buyer, Buyer-supplied software or interfacing, unauthorized modification or misuse, operation outside of the environmental specifications for the product, or improper site preparation or maintenance.

NO OTHER WARRANTY IS EXPRESSED OR IMPLIED. HP SPECIFICALLY DISCLAIMS THE IMPLIED WARRANTIES OF MERCHANTABILITY AND FITNESS FOR A PARTICULAR PURPOSE.

EXCLUSIVE REMEDIES

THE REMEDIES PROVIDED HEREIN ARE BUYER'S SOLE AND EXCLUSIVE REMEDIES. HP SHALL NOT BE LIABLE FOR ANY DIRECT, INDIRECT, SPECIAL, INCIDENTAL, OR CONSEQUENTIAL DAMAGES, WHETHER BASED ON CONTRACT, TORT, OR ANY OTHER LEGAL THEORY.

ASSISTANCE

Product maintenance agreements and other customer assistance agreements are available for Hewlett-Packard products.

For any assistance, contact your nearest Hewlett-Packard Sales and Service Office.

SAFETY SYMBOLS

The following safety symbols are used throughout this manual and in the instrument. Familiarize yourself with each of the symbols and its meaning before operating this instrument.



Instruction manual symbol. The instrument will be marked with this symbol when it is necessary for the user to refer to the instruction manual in order to protect the instrument against damage. Location of pertinent information within the manual is indicated by use of this symbol in the table of contents.



Indicates dangerous voltages are present. Be extremely careful.



The CAUTION sign denotes a hazard. It calls attention to a procedure which, if not correctly performed or adhered to, could result in damage to or destruction of the instrument. Do not proceed beyond a CAUTION sign until the indicated conditions are fully understood and met.



The WARNING sign denotes a hazard. It calls attention to a procedure which, if not correctly performed or adhered to, could result in injury or loss of life. Do not proceed beyond a WARNING sign until the indicated conditions are fully understood and met.

GENERAL SAFETY CONSIDERATIONS

WARNING

BEFORE THIS INSTRUMENT IS SWITCHED ON, make sure it has been properly grounded through the protective conductor of the ac power cable to a socket outlet provided with protective earth contact. Any interruption of the protective (grounding) conductor, inside or outside the instrument, or disconnection of the protective earth terminal can result in personal injury.

WARNING

There are voltages at many points in the instrument which can, if contacted, cause personal injury. Be extremely careful. Any adjustments or service procedures that require operation of the instrument with protective covers removed should be performed only by trained service personnel.

CAUTION

BEFORE THIS INSTRUMENT IS SWITCHED ON, make sure its primary power circuitry has been adapted to the voltage of the ac power source. Failure to set the ac power input to the correct voltage could cause damage to the instrument when the ac power cable is plugged in.

HP 70000 MODULAR MEASUREMENT SYSTEM DOCUMENTATION OUTLINE

Instruments and modules of the HP 70000 Modular Measurement System are documented to varying levels of detail. Modules that serve as masters of an instrument require operation information in addition to installation and verification instructions. Modules that function as slaves in a system require only a subset of installation and verification information.

Manuals Supplied with Module

INSTALLATION AND VERIFICATION MANUAL

Topics covered by this manual include installation, specifications, verification of module operation, and some troubleshooting techniques. Manuals for modules that serve as instrument masters will supply information in all these areas; manuals for slave modules will contain only information needed for slave module installation and verification. Master module documentation may also include some system-level information.

OPERATION MANUAL

Operation Manuals usually pertain to multiple- and single-module instrument systems. Topics include preparation for module use, module functions, and softkey definitions.

PROGRAMMING MANUAL

Programming Manuals also pertain to multiple- and single-module instrument systems. Programming Manual topics include programming fundamentals and definitions for remote programming commands.

Service Manual, Available Separately

TECHNICAL REFERENCE

When available, this manual provides service information for a module, including performance verification, adjustments, troubleshooting, replaceable parts lists, replacement procedures, schematics, and component location diagrams. For ordering information, contact an HP Sales and Service Office.

CONTENTS

1. General Information

Introduction	1-1
Description	1-1
Safety Considerations	1-1
Modules Covered by Manual	1-3
Serial Numbers	1-3
Manual Updating Supplement	1-3
Initial Inspection	1-4
Accessories Supplied	1-4
Front/Rear-Panel Features	1-5
Status ACT	1-5
Status ERR	1-5
Probe Power (HP 70904A)	1-6
RF Input	1-6
Module Latch	1-6
1ST LO IN	1-6
1ST LO OUT	1-6
21.4 MHz OUT	1-6
300 MHz IN	1-6
321.4 MHz OUT (HP 70905A/5B/6A/6B)	1-7
321.4 MHz IN (HP 70905A/5B/6A/6B)	1-7
Mainframe/Module Interconnect	1-7
Electrostatic Discharge	1-7
Reducing Damage Caused by ESD	1-7
Sales and Support Offices	1-8
How to Return the Module for Service	1-8
Original Packaging	1-8
Other Packaging	1-10

2. Installation

Introduction	2-1
Preparation for Use	2-1
Determining the HP-MSIB Address	2-1
Setting the HP-MSIB Address Switch	2-2
Installing the Module	2-2
Connecting the RF Cables	2-3

3. Specifications

3-1

4. Verification

4-1

5. Troubleshooting

Introduction	5-1
Status Error Indicator	5-1
Error Messages	5-1
Operating Errors (2000 – 2999)	5-1
Hardware-Warning Messages (6000 – 6999)	5-2
Hardware-Broken Messages (7000 – 7999)	5-2

Chapter 1

GENERAL INFORMATION

Introduction

This Installation and Verification Manual contains information required to install and verify HP 70904A, HP 70905A, HP 70905B, HP 70906A, and HP 70906B RF Modules. For information on installing and verifying HP 70000 Modular Spectrum Analyzers, refer to the local-oscillator module's Installation and Verification Manual.

This manual contains the following five chapters:

- **Chapter 1 General Information** describes module accessories and features.
- **Chapter 2 Installation** provides steps for configuring and installing the module into an HP 70000 Modular Spectrum Analyzer.
- **Chapter 3 Specifications** lists any module specifications and characteristics.
- **Chapter 4 Verification** contains tests required to verify module specifications.
- **Chapter 5 Troubleshooting** explains front-panel error lights and error codes produced by RF modules.

Description

The HP 70904A/5A/5B/6A/6B RF Modules serve as front ends for RF and microwave spectrum analyzer systems. The complete measuring system includes RF, IF, Local Oscillator, and Display modules installed into an HP 70000 Spectrum Analyzer mainframe. Each RF module converts the incoming signal to a 21.4 MHz IF. The HP 70905B and HP 70906B, intended for use with a preselector, do not have an input attenuator; therefore, the HP 70905B and HP 70906B should not be used as a stand-alone front-end. Figure 1-1 illustrates the RF Modules with accessories supplied. Table 1-1 lists the frequency range covered by each module.

Safety Considerations

Before operating this module, you should familiarize yourself with any safety markings on the module and the safety instructions in this manual. This module has been manufactured and tested according to international safety standards. However, to ensure safe operation of the module and personal safety of the user and

70904A RF SECTION
RANGE 100 kHz - 2.9 GHz

STATUS
ACT ERR

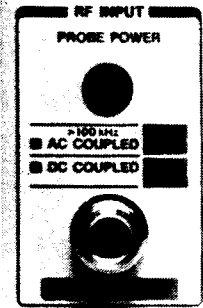

HP 70904A

70905A RF SECTION
RANGE 50 kHz - 22 GHz

STATUS
ACT ERR



HP 70905A

HP 70905B RF SECTION
RANGE 50 kHz - 22 GHz

STATUS
ACT ERR

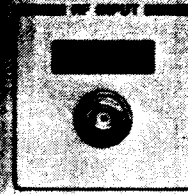

HP 70905B
HP 70906B

70906A RF SECTION
RANGE 50 kHz - 22.5 GHz

STATUS
ACT ERR

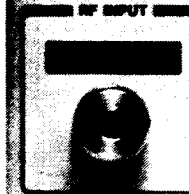

HP 70906A

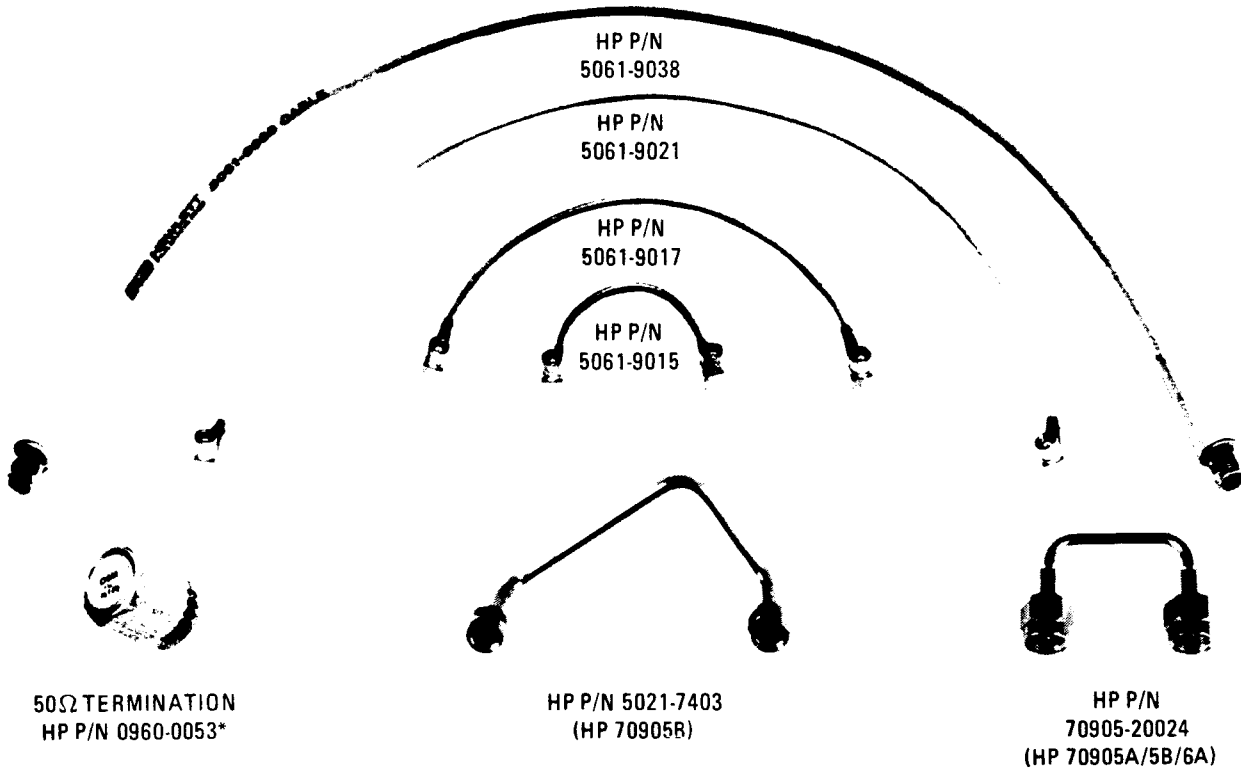

*ATTACHED TO REAR PANEL

Figure 1-1. RF Modules with Accessories Supplied

Table 1-1. Module Frequency Range

Module	Frequency Range
HP 70904A	100 Hz to 2.9 GHz
HP 70905A	50 kHz to 22 GHz
HP 70905B	50 kHz to 22 GHz
HP 70906A	50 kHz to 26.5 GHz
HP 70906B	50 kHz to 26.5 GHz

service personnel, the cautions and warnings in this manual must be followed. Refer to the summary of safety considerations at the front of this manual.

Modules Covered by Manual

SERIAL NUMBERS

Attached to the front frame of your module is a mylar serial-number label. The serial number is in two parts. The first four digits and letter are the serial number prefix; the last five digits are the suffix. See figure 1-2. The prefix is the same for all identical modules; it changes only when a change is made to the module. The suffix, however, is assigned sequentially and is different for each module. The contents of this manual apply to modules with the serial number prefix(es) listed under SERIAL NUMBERS on the title page.

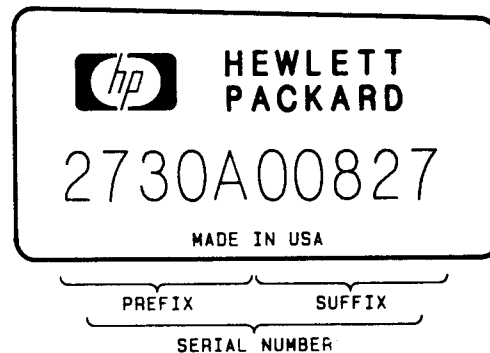

Figure 1-2. Typical Serial Number Label

MANUAL UPDATING SUPPLEMENT

A module manufactured after the printing of this manual might have a serial number prefix that is not listed on the title page. This unlisted serial number prefix indicates that the module is different from those with the serial prefix listed on the title page. The manual for this newer module may be accompanied by a Manual Updating Supplement. This supplement contains change information that explains how to adapt the manual to the newer module.

In addition to change information, the supplement may contain corrections to errors in the manual. To keep this manual as current and accurate as possible, Hewlett-Packard recommends that you periodically request the latest Manual Updating Supplement. The supplement carries a manual identification block that includes the model number, print date of the manual, and manual part number. Complimentary copies of the supplement are available from Hewlett-Packard. Addresses of Hewlett-Packard offices are located at the end of this chapter.

Initial Inspection

Inspect the shipping container for damage. If the shipping container or cushioning material is damaged, it should be kept until the contents of the shipment have been checked for completeness and the module has been checked mechanically and electrically. Refer to Accessories Supplied in this chapter for a list of shipment contents.

If the shipping contents are incomplete, or if the module does not pass the procedures in chapter 4, notify the nearest Hewlett-Packard office. A list of Sales and Service Offices is supplied at the end of this chapter. If the shipping container is damaged, or the cushioning material shows signs of stress, notify the carrier as well as the Hewlett-Packard office. Keep the shipping materials for the carrier's inspection. The HP office will arrange for repair or replacement without waiting for claim settlement.

Accessories Supplied

The module may be ordered separately or as part of a preconfigured spectrum analyzer. The accessories supplied with the module are listed in table 1-2 and displayed in figure 1-1. When ordered with a preconfigured spectrum analyzer, the module comes with RF cables that match the factory configuration. Refer to the local oscillator's Installation and Verification Manual for a list of cables provided with a system.

Table 1-2. Accessories Supplied

Accessory	HP Part Number
50Ω Termination: SMA (m) connector	0960-0053
Coax RF Cables: SMB (f) connectors, 50Ω, 9 cm (3-1/2 in.) SMB (f) connectors, 50Ω, 19 cm (7-1/2 in.) SMB (f) connectors, 50Ω, 39 cm (15-3/8 in.) SMA (m) connectors, 50Ω, 51 cm (20 in.)	5061-9015 5061-9017 5061-9021 5061-9038
Semi-Rigid RF Cables: SMA (m) connectors, 50Ω (HP 70905A/5B/6A only) SMA (m) connectors, 50Ω (HP 70905B/6B only)	70905-20024 5021-7403

Front/Rear-Panel Features

Front- and rear-panel features are very similar among the RF modules. The following text describes each feature and identifies the differences among modules. Figure 1-3 illustrates the features using an HP 70904A front panel and an HP 70906A rear panel.

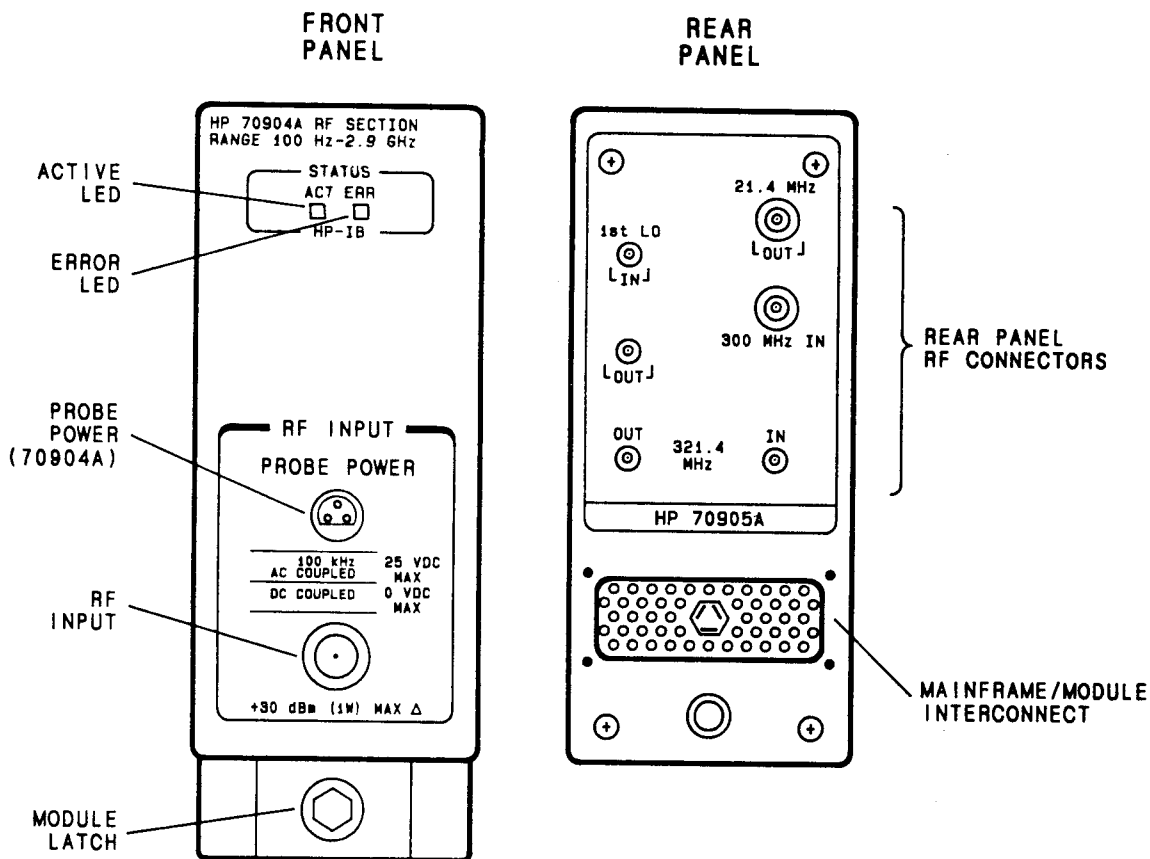

Figure 1-3. Front- and Rear-Panel Features

STATUS ACT

The Status ACT LED lights when the RF module is active.

STATUS ERR

Errors are indicated when the Status ERR LED lights up. Refer to chapter 5, Troubleshooting, for more information.

PROBE POWER (HP 70904A)

The probe power jack (provided on HP 70904A modules only) supplies power for accessories such as the HP 10855A Preamplifier.

RF INPUT

The RF Input connector provides a 50 Ω input impedance with the connector types listed in table 1-3.

Table 1-3. RF Input Connectors

Module	Input Connector
HP 70904A	Type N (f)
HP 70905A	Type N (f)
HP 70905B	SMA (f)
HP 70906A	APC-3.5 (m)
HP 70906B	K (f)

MODULE LATCH

An 8 mm hex-ball driver is used to turn the module hex-nut latch for installation of the module in a mainframe. Refer to chapter 2 for instructions on installing the module.

1ST LO IN

This SMA connector provides for the input of the first converter's local-oscillator signal. The signal originates from the local-oscillator module and is 3.0 to 6.6 GHz at approximately +1.5 to +12 dBm.

1ST LO OUT

An SMA connector supplies an auxiliary output of the 1st LO IN signal. Power out is approximately +1.5 to +12 dBm. Terminate with a 50 Ω load when not in use.

21.4 MHz OUT

The final IF signal exits this SMB connector. The signal is the input for IF modules.

300 MHz IN

This SMB connector provides for input of the last converter's local-oscillator signal. This signal comes from the local oscillator module.

321.4 MHz OUT (HP 70905A/5B/6A/6B)

Access to the first IF signal in high band is provided by this SMA connector. The module uses high band for input frequencies greater than 2.7 GHz. The output is from 100 MHz to 700 MHz and tracks the 21.4 MHz IF with an offset of $-21 \text{ dBm} \pm 3 \text{ dB}$. The output impedance is 50Ω . During normal operation, a semi-rigid cable connects the 321.4 MHz OUT and 321.4 MHz IN jacks.

321.4 MHz IN (HP 70905A/5B/6A/6B)

During normal operation, a semi-rigid cable connects the 321.4 MHz OUT and 321.4 MHz IN jacks. Refer to the explanation of the 321.4 MHz OUT jack.

MAINFRAME/MODULE INTERCONNECT

This multiple-pin connector plugs into the mainframe and provides the power supplies and Modular System Interface Bus for the module.

Electrostatic Discharge

Electrostatic discharge (ESD) can damage or destroy electronic components. All work performed on assemblies consisting of electronic components should be done at a static-free work station. Figure 1-4 is an example of a static-safe work station using two types of ESD protection:

- conductive table mat and wrist-strap combination
- conductive floor mat and heel-strap combination

Table 1-4 lists static-safe accessories that can be obtained from Hewlett-Packard.

REDUCING DAMAGE CAUSED BY ESD

The following suggestions may help reduce ESD damage that occurs during testing and servicing operations.

- Before connecting any coaxial cable to an analyzer connector for the first time each day, momentarily ground the center and outer conductors of the cable.
- Personnel should be grounded with a resistor-isolated wrist strap before touching the center pin of any connector and before removing any assembly from the unit.
- Be sure that all instruments are properly earth-grounded to prevent a buildup of static charge.

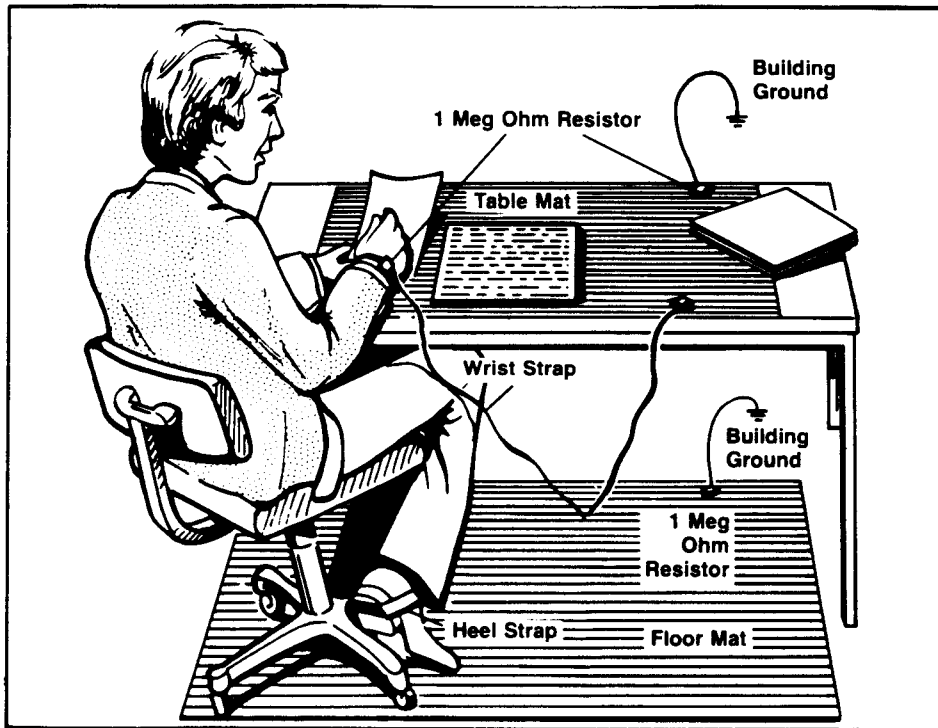

Figure 1-4. Example of a Static-Safe Work Station

Sales and Service Offices

Hewlett-Packard has Sales and Service offices around the world providing complete support for HP 70000 Modular Spectrum Analyzers. To obtain servicing information or to order replacement parts, contact the nearest Hewlett-Packard Sales and Service Office listed in table 1-5. In any correspondence or telephone conversations, refer to the module by its model number.

How to Return the Module for Service

If you are returning the module to Hewlett-Packard for servicing, fill in and attach a blue service tag. Service tags are supplied at the end of this manual.

Please be as specific as possible about the nature of the problem. If you have recorded any error messages that appeared on the screen or have any other specific data on the performance of the module, please send a copy of this information with the unit.

ORIGINAL PACKAGING

Before shipping, pack the unit in the original factory packaging materials. If the original materials were not retained, identical packaging materials are available through any Hewlett-Packard office. Figure 1-5 illustrates the factory packaging materials.

Table 1-4. Static-Safe Accessories

Accessory	Description	HP Part Number
Static-control mat and ground wire	Set includes: 3M static control mat 0.6m × 1.2m (2 ft. × 4 ft.) and 4.6m (15 ft.) ground wire (The wrist strap and wrist strap cord are <i>not</i> included. They must be ordered separately.)	9300-0797
Wrist strap cord	1.5m (5 ft.)	9300-0980
Wrist strap	Large Small	9300-0985 9300-0986
ESD heel strap	Reusable 6 to 12 months	9300-1169
Shoe ground strap	One-time use only	9300-0793
Hard-surface static-control mat*	Large, black, 1.2m × 1.5m (4 ft. × 5 ft.) Small, black, 0.9m × 1.2m (3 ft. × 4 ft.)	92175A 92175C
Soft-surface static-control mat*	Brown, 1.2m × 2.4m (4 ft. × 8 ft.)	92175B
Tabletop static control mat*	58 cm × 76 cm (23 in. × 30 in.)	92175T
Anti-static carpet*	Small, 1.2m × 1.8m (4 ft. × 6 ft.) natural color russet color Large, 1.2m × 2.4m (4 ft. × 8 ft.) natural color russet color	92176A 92176C 92176B 92176D
<p>* These accessories can be ordered from: Hewlett-Packard Company Computer Supplies Operations 1320 Kifer Road Sunnyvale, California 94086 Phone: (408) 738-8858</p>		

OTHER PACKAGING



CAUTION

Module damage can result from using packaging materials other than those specified. Never use styrene pellets in any shape as packaging materials. They do not adequately cushion the equipment or prevent it from shifting in the carton. They also cause equipment damage by generating static electricity.

You can repackage the module with commercially available materials, as follows:

1. Attach a completed service tag to the module.
2. Wrap the module in anti-static plastic to reduce the possibility of damage caused by electrostatic discharge.
3. Use a strong shipping container. A double-walled, corrugated cardboard carton with 159-kg (350-lb) bursting strength is adequate. The carton must be both large enough and strong enough to accommodate the module. Allow at least three to four inches on all sides of the module for packing material.
4. Surround the module with three to four inches of packing material and prevent the equipment from moving in the carton. If packing foam is not available, the best alternative is S.D.-240 Air Cap™ from Sealed Air Corporation (Commerce, California, 90001). Air Cap looks like a plastic sheet filled with 1-1/4 inch air bubbles. Use the pink-colored Air Cap to reduce static electricity. Wrapping the module several times in this material should both protect and prevent it from moving in the carton.
5. Seal the shipping container securely with strong nylon adhesive tape.
6. Mark the shipping container “FRAGILE, HANDLE WITH CARE” to assure careful handling.
7. Retain copies of all shipping papers.

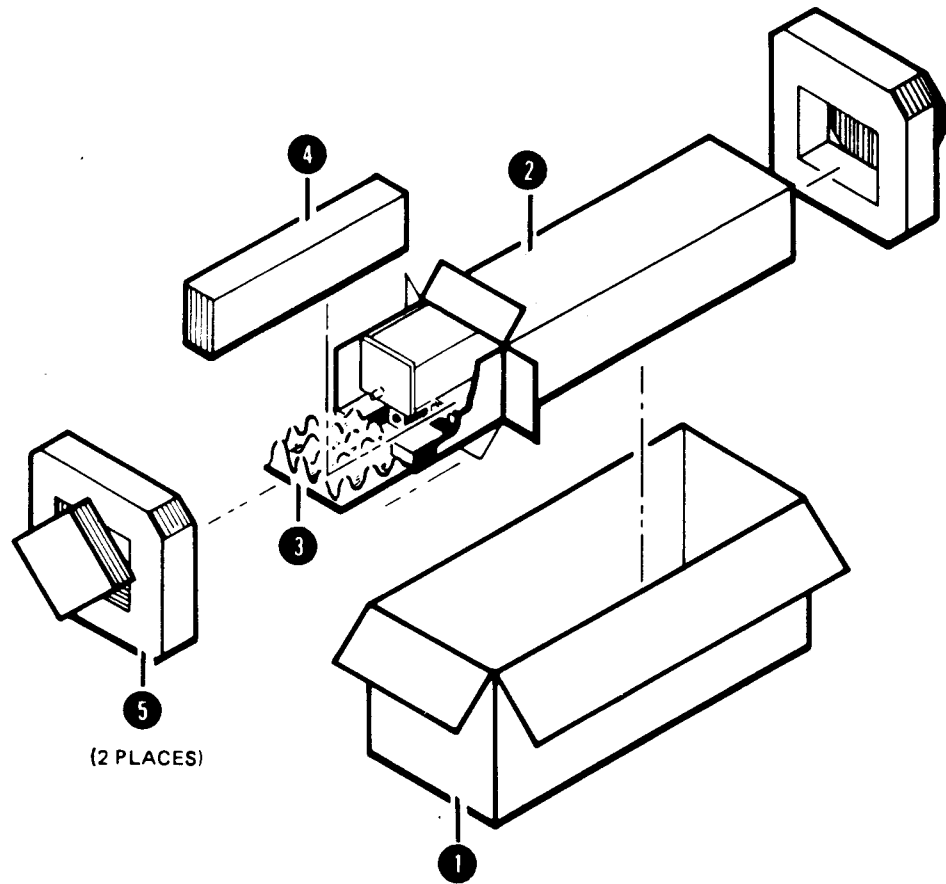

ITEM	QTY	HP PART NO.	DESCRIPTION
1	1	9211-5118	CARTON-OUTER
2	1	9211-5119	CARTON-INNER
3	1	5180-2369	CARTON-SLIDER
4	2	4280-0493	FOAM INSERT (FOR QUANTITY SEE TEXT)
5	2	5180-2370	FOAM PADS

Figure 1-5. Factory Packaging Materials

Table 1-5. HP Sales and Service Offices (1 of 2)

<p>IN THE UNITED STATES</p> <p>California Hewlett-Packard Co. P.O. Box 4230 1421 South Manhattan Ave. Fullerton, CA 92631 (714) 999-6700</p> <p>Hewlett-Packard Co. 333 Logue Ave. Mountain View, CA 94040 (415) 969-0880</p> <p>Colorado Hewlett-Packard Co. 24 Inverness Place, East Englewood, CO 80112 (303) 649-5000</p> <p>Georgia Hewlett-Packard Co. P.O. Box 105005 2000 South Park Place Atlanta, GA 30339 (404) 955-1500</p> <p>Illinois Hewlett-Packard Co. 5201 Tollview Drive Rolling Meadows, IL 60008 (312) 255-9800</p> <p>New Jersey Hewlett-Packard Co. 120 W. Century Road Paramus, NJ 07653 (201) 265-5000</p> <p>Texas Hewlett-Packard Co. 930 E. Campbell Rd. Richardson, TX 75081 (214) 231-6101</p>	<p>IN AUSTRALIA Hewlett-Packard Australia Ltd. 31-41 Joseph Street Blackburn, Victoria 3130 895-2895</p> <p>IN CANADA Hewlett-Packard (Canada) Ltd. 17500 South Service Road Trans-Canada Highway Kirkland, Quebec H9J 2X8 (514) 697-4232</p> <p>IN FRANCE Hewlett-Packard France F-91947 Les Ulis Cedex Orsay (6) 907-78-25</p> <p>IN GERMAN FEDERAL REPUBLIC Hewlett-Packard GmbH Vertriebszentrale Frankfurt Berner Strasse 117 Postfach 560 140 D-6000 Frankfurt 56 (0611) 50-04-1</p> <p>IN GREAT BRITAIN Hewlett-Packard Ltd. King Street Lane Winnersh, Wokingham Berkshire RG11 5AR 0734 784774</p> <p>IN OTHER EUROPEAN COUNTRIES Hewlett-Packard (Schweiz) AG Allmend 2 CH-8967 Widen (Zurich) (0041) 57 31 21 11</p>
--	---

Table 1-5. HP Sales and Service Offices (2 of 2)

<p>IN JAPAN Yokogawa-Hewlett-Packard Ltd. 29-21 Takaido-Higashi, 3 Chome Suginami-ku Tokyo 168 (03) 331-6111</p> <p>IN PEOPLE'S REPUBLIC OF CHINA China Hewlett-Packard, Ltd. P.O. Box 9610, Beijing 4th Floor, 2nd Watch Factory Main Bldg. Shuang Yu Shu, Bei San Huan Rd. Beijing 28-0567</p> <p>IN SINGAPORE Hewlett-Packard Singapore Pte. Ltd. #08-00 Inchcape House 450-2 Alexandra Road Alexandra P.O. Box 58 Singapore, 9115 4731788</p>	<p>IN TAIWAN Hewlett-Packard Taiwan 8th Floor, Hewlett-Packard Building 337 Fu Hsing North Road Taipei (02) 712-0404</p> <p>IN ALL OTHER LOCATIONS Hewlett-Packard Inter-Americas 3200 Hillview Avenue Palo Alto, California 94304</p>
--	--

Chapter 2

INSTALLATION

Introduction

This chapter provides information on installing an RF module into an HP 70000 Modular Spectrum Analyzer mainframe. The information presented is general in nature. For more detailed information spectrum analyzer configuration and HP-MSIB (Hewlett-Packard Modular System Interface Bus) addressing, refer to the local oscillator's Installation and Verification Manual.

Preparation for Use

When properly installed, the module obtains both power and interface bus control through its rear-panel multiple-pin connector. All required RF signals enter and exit through RF connectors.

Installing the module requires the following steps:

- determining the HP-MSIB address
- setting the HP-MSIB address switch
- installing the module
- connecting the RF cables

DETERMINING THE HP-MSIB ADDRESS

HP 70000 Modular Spectrum Analyzers have HP-IB access through the analyzer's local oscillator module. The local oscillator uses HP-MSIB to communicate with RF modules; therefore, RF modules must be assigned an HP-MSIB address. They cannot be accessed using HP-IB.

The RF module's factory-preset address is 4,18 (row 4, column 18). Figure 2-1 illustrates a typical address map for a spectrum analyzer. It shows the relationship between modules and factory-preset HP-MSIB addresses. Normally, the RF module's address would not require changing. However, the address may have to be changed if factory-preset addresses of other modules have been changed.

Changing the HP-MSIB address requires an understanding of HP-MSIB addressing rules. For information on determining and assigning HP-MSIB addresses, refer to the local oscillator's Installation and Verification Manual.

ADDRESSING EXAMPLE

7				
6				
5				
R O W 4		RF SECT		
3				
2				
1		IF SECT		
0		LO/CTLR HP-1B10		
	17	18	19	20
	COLUMN			

THE HP 70001A MAINFRAME DOES NOT HAVE AN HP-MSIB ADDRESS. THE USUAL ADDRESS FOR THE HP 70205A OR HP 70206A DISPLAY IS ROW 0, COLUMN 4.

Figure 2-1. Typical Address Map

SETTING THE HP-MSIB ADDRESS SWITCH

If the module's address needs to be changed:

1. Find the group of address switches located on the left side-panel of the module. See figure 2-2 for an example of the switches.
2. Set the three switches labeled "row" to the binary value of the module's HP-MSIB row number. For example, if the row value is 4, set the switches to binary 100 as shown in figure 2-2.
3. Set the five switches labeled "column" to the binary value of the module's HP-MSIB column number. For example, if the column value is 18, set the switches to binary 10010 as shown in figure 2-2.

INSTALLING THE MODULE

Follow the steps below to install the module in the mainframe:

1. Set the mainframe LINE switch to OFF. See figure 2-3.
2. Open the mainframe front-panel door and slide the module into the mainframe. Modules can be placed in any order. Longer cables may have to be ordered for configurations requiring long cable lengths.
3. Press against the module front panel while tightening the hex-nut latch with an 8 mm hex-ball driver.
4. Close the mainframe front-panel door.

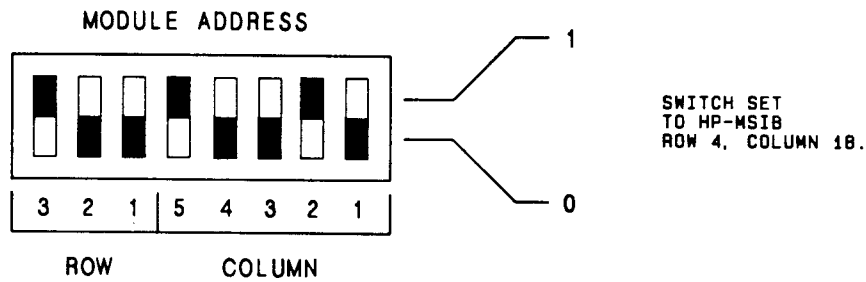

Figure 2-2. Module Address Switch

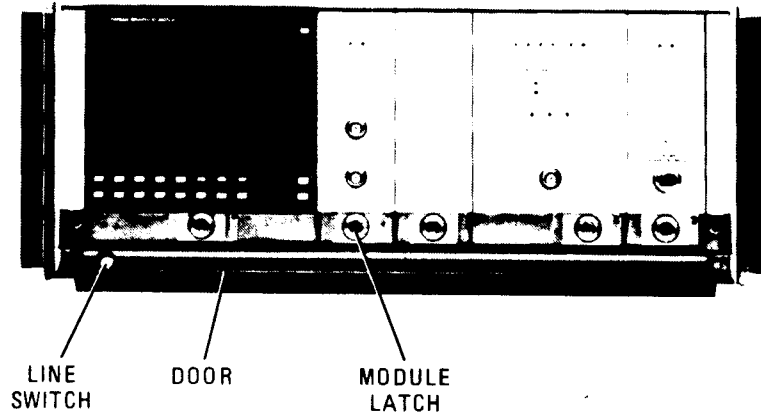

Figure 2-3. Module Installation

CONNECTING THE RF CABLES

Figure 2-4 illustrates typical rear-panel connections for the RF cables. Use the cables listed in table 2-1 to make the connections in the steps below.

In table 2-1, cables labeled 1/8 span will connect between 1/8 size modules in adjacent positions. Cables labeled 7/8 span will connect between a module in the first mainframe position and a module seven positions away in the eighth mainframe position. Modules come with one each of the 1/8, 3/8, and 7/8 span cables. Additional cables may be ordered from any HP Sales and Service Office.

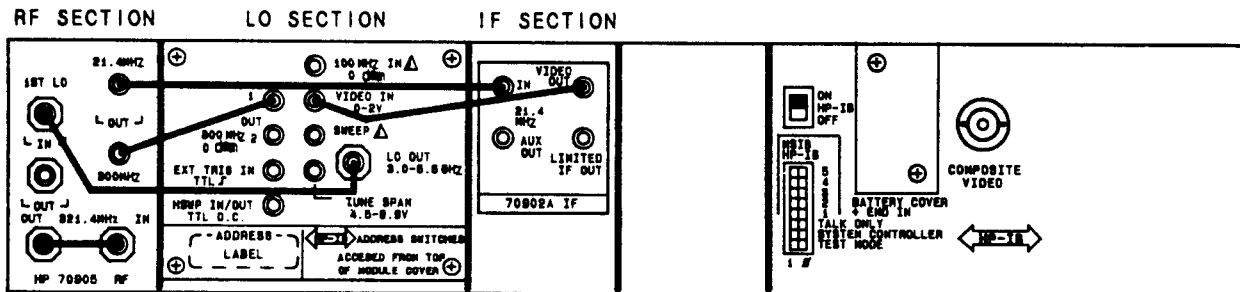

Figure 2-4. Typical Rear-Panel Connections

Cables marked SMB have snap-on connectors. Cables marked SMA have threaded connectors which require the use of a 5/16-inch wrench.



Use no more than six inch-pounds of torque when tightening SMA connectors.

1. Connect one of the SMB cables listed in table 2-1 between the RF module's 21.4 MHz OUT jack and the IF module's 21.4 MHz IN jack.
2. Use an SMB coax cable to connect the RF module's 300 MHz jack with the LO module's 300 MHz OUT #1 jack.
3. Connect the RF module's 1ST LO IN jack with the LO module's LO OUT jack. Use the SMA coax cable supplied in a package labeled HP 5061-9038.
4. On HP 70905A/5B/6A/6B modules, connect the 321.4 MHz OUT jack to the 321.4 MHz IN jack using a semi-rigid cable (HP Part Number 70905-20024).
5. On an HP 70905B, connect the front-panel RF INPUT with the HP 70600A Preselector's front-panel RF OUTPUT. Use a semi-rigid cable (HP Part Number 5021-7403).
6. On an HP 70906B, connect the front-panel RF INPUT with the HP 70601A Preselector's front-panel RF OUTPUT. Use a semi-rigid cable (HP Part Number 5021-7403).

Table 2-1. RF Cables

Type	Length	HP Part Number
Coax, SMB (f), 50Ω	1/8 span, 9 cm (3-1/2 in.)	5061-9015
	2/8 span, 14 cm (5-1/2 in.)	5061-9016
	3/8 span, 19 cm (7-1/2 in.)	5061-9017
	4/8 span, 24 cm (9-3/8 in.)	5061-9018
	5/8 span, 29 cm (11-1/2 in.)	5061-9019
	6/8 span, 34 cm (13-3/8 in.)	5061-9020
	7/8 span, 39 cm (15-3/8 in.)	5061-9021
Coax, SMA (m), 50Ω	51 cm (20 in.)	5061-9038
Semi-rigid, SMA (m), 50Ω	321.4 MHz IN/OUT	70905-20024
	RF INPUT/OUTPUT	5021-7403

Chapter 3

SPECIFICATIONS

There are no specifications for HP 70904A/5A/5B/6A/6B RF modules. For system-level specifications and characteristics, refer to the local oscillator's Installation and Verification Manual.

Chapter 4

VERIFICATION

This chapter normally contains performance verification tests which test the electrical performance of the module against its specifications. Since there are no RF module specifications, no performance verification tests have been provided.

Chapter 5

TROUBLESHOOTING

Introduction

This chapter provides information on the front-panel STATUS ERR (error) indicator light and error messages produced by the RF module. Refer to the module's Technical Reference for component-level troubleshooting and service.

Status Error Indicator

A STATUS ERR (Error) indicator LED is located on the module's front panel. If the LED flashes at a 1 Hz rate, the module cannot communicate over HP-MSIB and is probably faulty. If the error-indicator LEDs of more than one of the spectrum analyzer's modules flash at a 1 Hz rate, refer to the local oscillator's Installation and Verification Manual.

NOTE

It is possible, but not probable, that a module may disrupt all HP-MSIB communication without its own error indicator flashing.

Error Messages

Spectrum analyzer error messages generated by RF sections are listed below. The messages are grouped by functional category; each category has its own series of numbers. Refer to the local oscillator's Installation and Verification Manual for a complete listing of all system error messages.

OPERATING ERRORS (2000 – 2999)

Operating errors are generated when the spectrum analyzer is used incorrectly. This usually occurs during remote operation. Refer to the local oscillator's Operation Manual and Programming Manual for information on both manual and remote spectrum analyzer operations.

2001 Illegal command (Illegal cmd)

This is a user-generated system protocol error.

2002 Illegal parameter

This is a user-generated system protocol error.

2009 Protocol error

This is a user-generated system protocol error.

HARDWARE-WARNING MESSAGES (6000 – 6999)

Hardware-warning messages indicate that module hardware may be broken. The spectrum analyzer can still make measurements, but the accuracy of the measurement cannot be guaranteed.

6000 EAROM unprotected

The memory-enable write switch is not in the protect position. This switch is located beneath the module's left side-panel near the HP-MSIB address switch.

HARDWARE-BROKEN MESSAGES (7000 – 7999)

Hardware-broken messages indicate the module may have faulty hardware. The messages report the module's model number and HP-MSIB address along with the error message.

7000 ROM Check error**7002 First LO unlevelled****7003 Second LO unlocked**

